

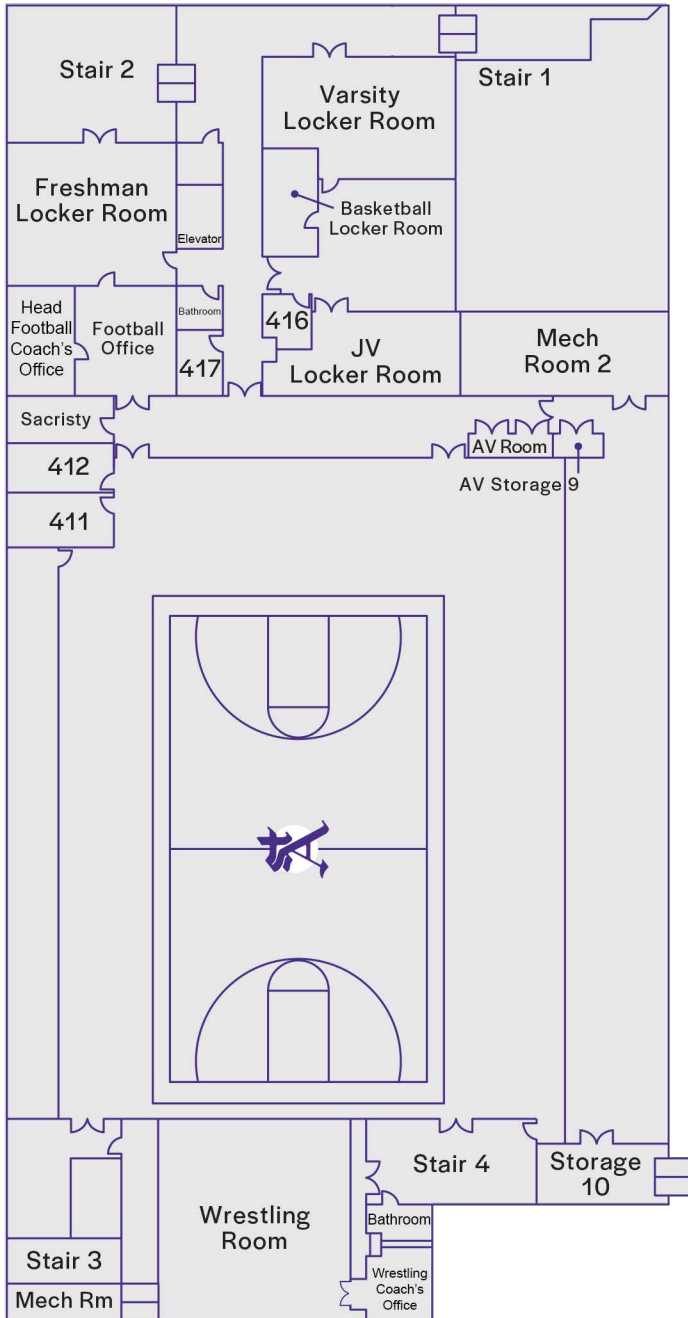

# St. Augustine High School

## St. Augustine Common-Gymnasium

### 1<sup>st</sup> Floor



### Terrace

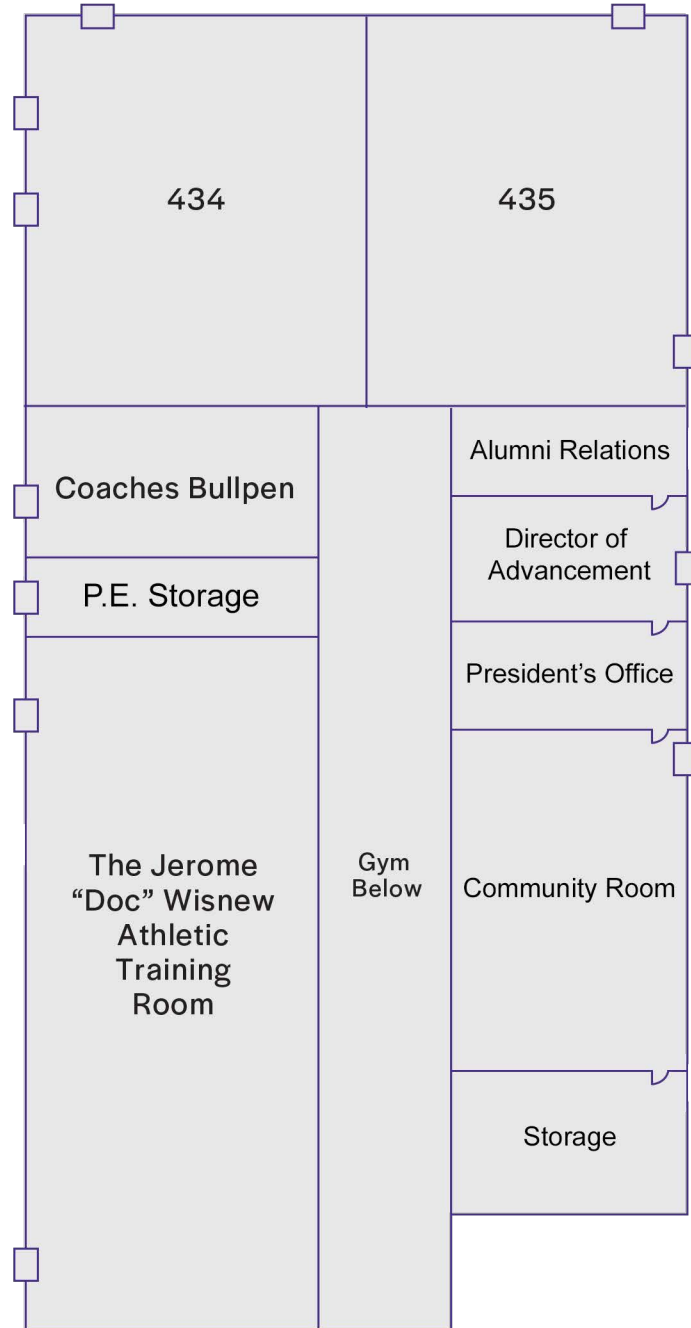



# St. Augustine High School

## St. Augustine Common-Gymnasium

### 1<sup>st</sup> Level

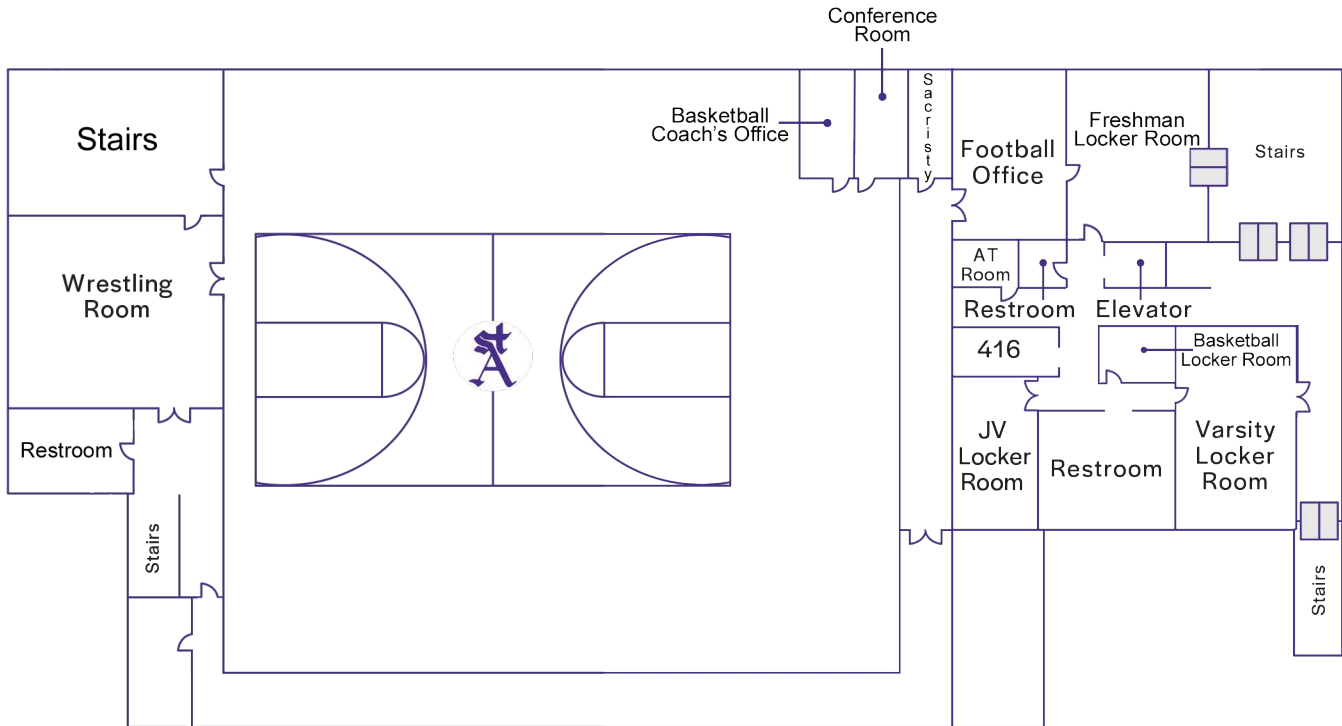



# St. Augustine High School

## St. Augustine Common-Gymnasium

### 2<sup>nd</sup> Level

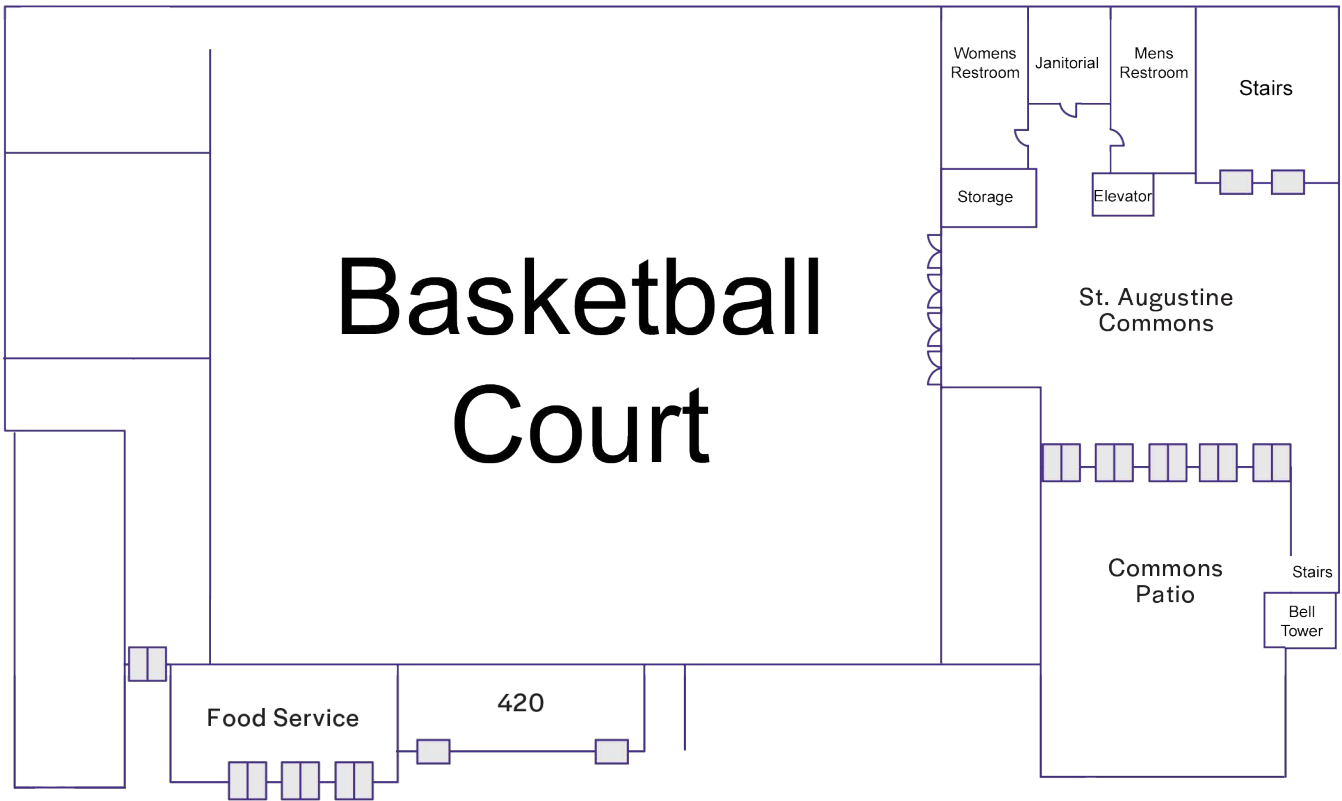



# St. Augustine High School

## St. Augustine Common-Gymnasium

### Terrace Level

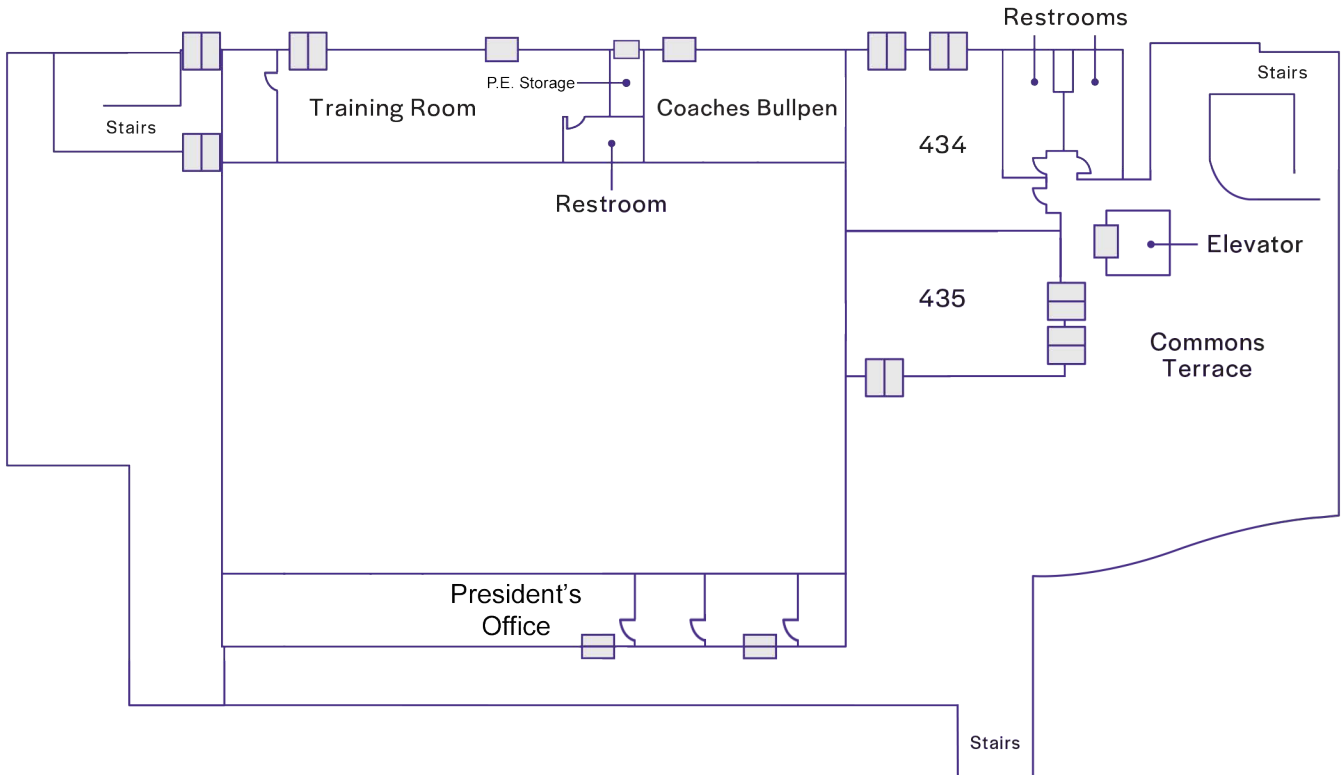



# St. Augustine High School

## Vasey Hall

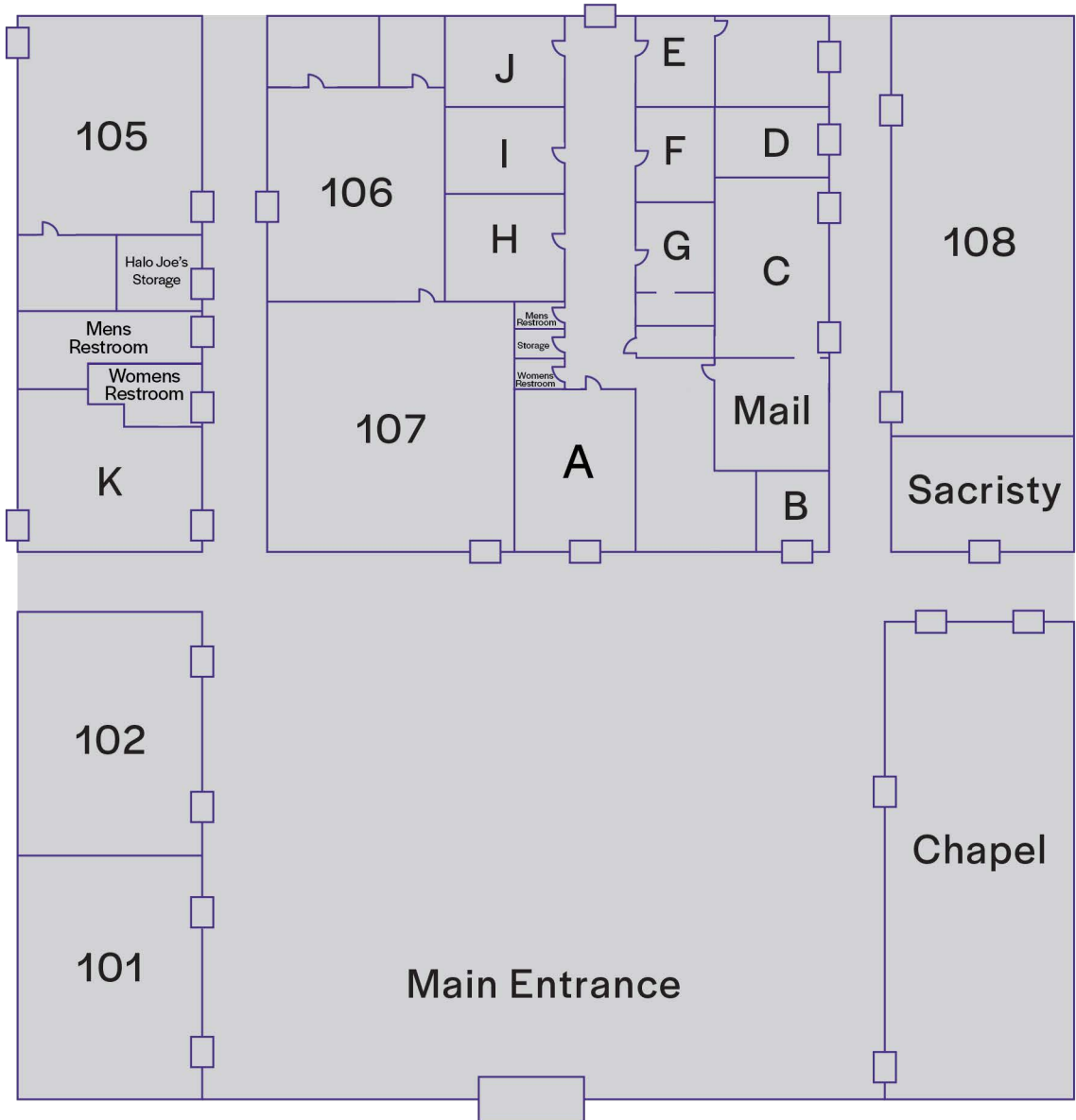

- A. Main Office/Reception
- B. Admissions
- C. Faculty Lounge/Resources
- D. Finance Manager
- E. Administrative Assistant

- F. Director of Finance/Facility
- G. Registrar
- H. Alumni / Advancement
- I. Assistant Principal Academics
- J. Principal's Office
- K. Halo Joe's

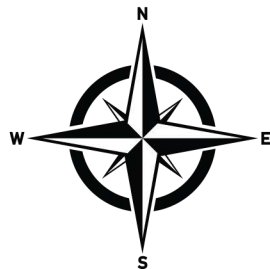



# St. Augustine High School

## Mendel Hall

### 1<sup>st</sup> Floor

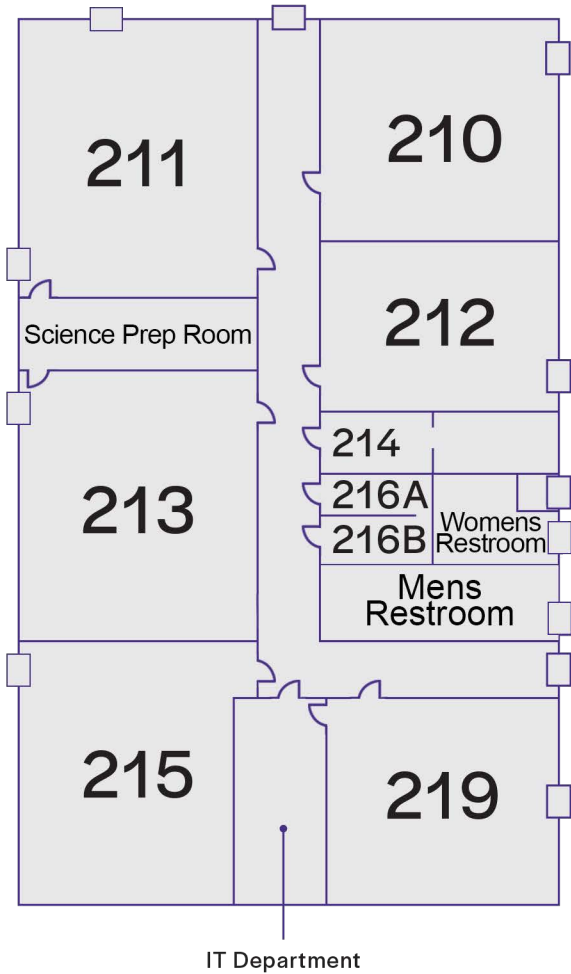

### 2<sup>nd</sup> Floor

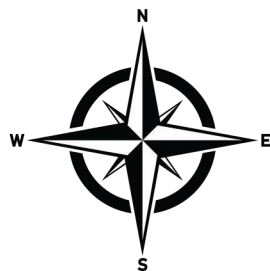
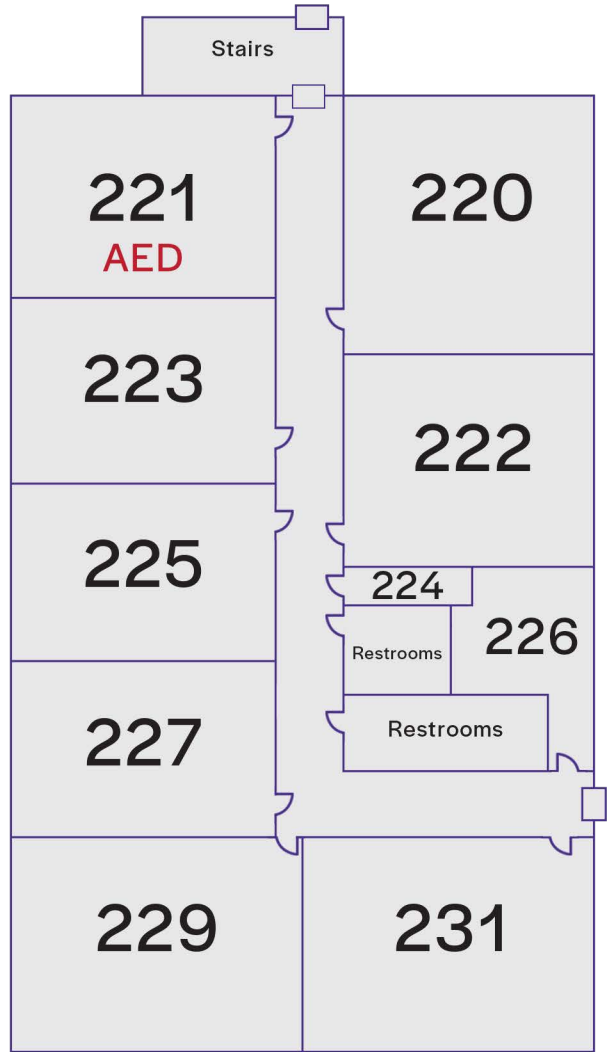



# St. Augustine High School

## Villanova Hall

### 1<sup>st</sup> Floor

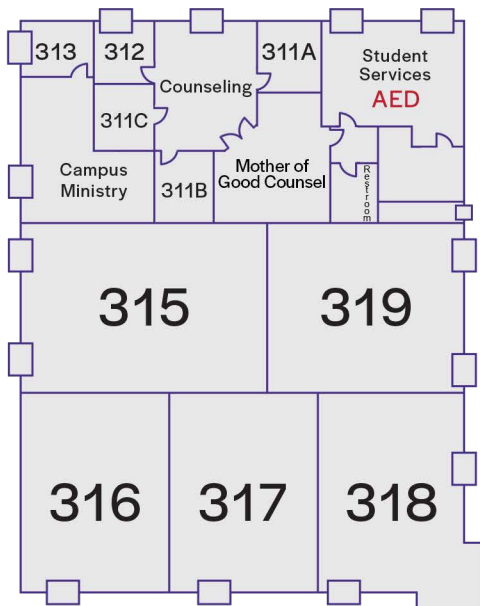

### 2<sup>nd</sup> Floor

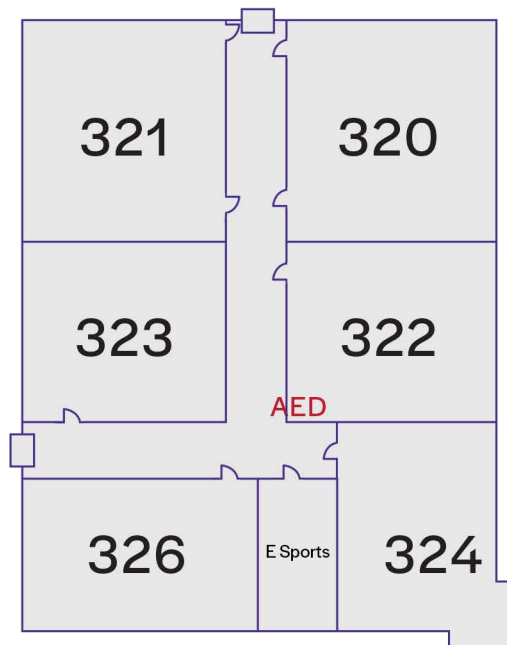

### 3<sup>rd</sup> Floor

